



ST/VT

VARIABLE TEMP GLASSFRONT VENDOR (GVC2 Controller)



MODELS:

3521/3521A – ST 3000 (3 WIDE)

3519/3519A – ST 5000 (5 WIDE)

3520 – VT 3000

3517 – VT 5000

SERVICE MANUAL

TABLE OF CONTENTS

| | |
|---|----|
| INTRODUCTION | 3 |
| SPECIFICATIONS | 3 |
| UNPACKING | 4 |
| INSTALLATION | 4 |
| LOADING PRODUCTS | 6 |
| CONTROLLER FUNCTIONS | 8 |
| SERVICE MODE | 9 |
| BASIC PROGRAMMING SETUP | 9 |
| 1 TUBE FILL/ DISPENSE COINS | 10 |
| 2 MOTOR COUNT | 10 |
| 3 OPTIONS | 10 |
| 4 CONFIGURATION | 11 |
| 5 PRICING | 13 |
| 6 ACCOUNTING | 14 |
| 7 ADVANCED OPTIONS | 14 |
| 8 TEST VEND | 15 |
| 0 DIAGNOSTIC | 15 |
| CUSTOMER LEAD THROUGH MESSAGES | 17 |
| TEMPERATURE CONTROL | 17 |
| SENSORS | 17 |
| FACTORY DEFAULT SETTINGS | 18 |
| REFRIGERATION | 19 |
| REFRIGERATION TROUBLESHOOTING | 19 |
| TROUBLESHOOTING CIRCUITS WITH MULTI-METER | 21 |
| PREVENTIVE MAINTENANCE | 22 |
| PARTS ORDERING PROCEDURE | 24 |
| BEFORE CALLING FOR SERVICE | 24 |

Please have the model and serial numbers if you need service and parts information. The numbers are on the identification plate located on the back side of the cabinet of the vending machine.

MODEL NUMBER: _____

SERIAL NUMBER: _____

If you have any questions pertaining to information in the manual, replacement parts or the operation of the vendor, then you should contact your local distributor or:

VendNet
 165 North 10th Street
 Waukee, Iowa 50263
 Phone: (888) 259-9965
 Parts Fax: (515) 274-5775
 Sales Fax: (515) 274-0390
 E-mail: vendnet@vendnetusa.com

INTRODUCTION

This manual contains instructions, service and installation guidelines for the **ST/VT Vendor**. Please read this manual thoroughly and follow instructions. The initial set-up of a vending machine is a very important step of insuring that the equipment operates in a trouble-free manner. The top compartment can have an optional heater system to provide further temperature separation across varying ambient temperatures. The bottom compartment has a temperature sensor and an insulated refrigeration system. Cool air is drawn from the refrigeration system's evaporator coils through the air duct and is deflected into the bottom zone by a moveable air deflector. There are openings in the bottom trays to allow air to circulate around the products.

All programming of pricing, vend functions and features are also done at the controller. Selections can be priced individually from \$.01 to \$655.35. The vending sequence is "first-in, first-out" for each selection, permitting stock rotation to maintain fresh products in the vending area.

Each **ST/VT Vendor** has the capability of supporting multiple "satellite" vending machines (one can/bottle satellite, and potentially 2 USD satellites).. For details on the satellite vendor, refer to the Service Manual pertaining to the specific installation instructions.

SPECIFICATIONS

DIMENSIONS & WEIGHTS

| TYPE | ST/VT (3 WIDE) | | ST/VT 5000 (5 WIDE) | |
|--------------------------------|--------------------|------------|---------------------|-------------|
| MODEL | 3520/3521 | 3520/3521A | 3517/3519 | 3517A/3519A |
| WIDTH | 29.5 in. (74.9 cm) | | 41.2 in. (104.6 cm) | |
| DEPTH | 38 in. (96.5 cm) | | | |
| HEIGHT | 72 in. (182.9 cm) | | | |
| ESTIMATED WEIGHT ¹ | 693 lbs (614 kg) | | 816 lbs (370 kg) | |
| EST. SHIPPING WT. ¹ | 722 lbs (327 kg) | | 846 lbs (384 kg) | |

Note: ¹ Weights will vary depending on tray configuration and optional equipment installed.

ELECTRICAL

| MODEL | | Panasonic Super 1/3 Hp | | Danfoss 1/2 Hp | |
|--------------|------------------|------------------------|------------|----------------|------------|
| VOLTAGE | | 115 VAC | 230 VAC | 115 VAC | 230 VAC |
| CYCLE | | 60 Hz | 50 Hz | 60 Hz | 50 Hz |
| NOMINAL AMPS | HEATED GLASS | 8.0 Amps | 4.0 Amps | 10.5 Amps | 5.2 Amps |
| | NON HEATED GLASS | 7.0 Amps | 3.5 Amps | 9.5 Amps | 4.8 Amps |
| TRANSFORMER | | 110/24 VAC | 230/24 VAC | 110/24 VAC | 230/24 VAC |

REFRIGERATION

| HORSEPOWER | Panasonic Super 1/3 Hp | Danfoss 1/2 Hp |
|-------------|------------------------|---------------------|
| TYPE | Hermetically Sealed | Hermetically Sealed |
| CONTROLS | Electronic | Electronic |
| REFRIGERANT | R-134a | R-134a |
| CHARGE | 20 oz | 16 oz |

COIN CHANGER, BILL VALIDATOR, CARD READER

| TYPE | Any MDB Peripheral Device |
|------|---------------------------|
|------|---------------------------|

VENDOR OPERATION

| LOCATION | Suitable for indoor use only |
|-----------------------------------|--|
| RECOMMENDED OPERATING TEMPERATURE | Between 32° and 100° Fahrenheit (0° and 38° Celsius) |

UNPACKING

This vending machine was thoroughly inspected before leaving the factory and the delivering carrier has accepted this vendor as their responsibility. Note any damage or irregularities at the time of delivery and report them to the carrier. Request a written inspection report from the claims inspector to file any claim for damage. File the claim with the carrier (not the manufacturer) within 15 days after receipt of the vending machine.

Carefully remove the outside packing material so as not to damage the finish or exterior of the vending machine. Inspect the vending machine for concealed shipping damage. Report any damage hidden by the shipping material directly to the delivering carrier on a hidden damage report.

Record the model number and serial number of the vendor for your records. These numbers can be found on the Serial Plate on the rear of the cabinet and/or inside the vendor. Refer to these numbers on all correspondence and inquiries pertaining to this vendor.

Remove the shipping skids by placing a 2x6 under the vendor, inserting a large screwdriver or prying tool into the groove and splitting it in two. Turn the leveling screws in as far as possible. (Figure 3a).

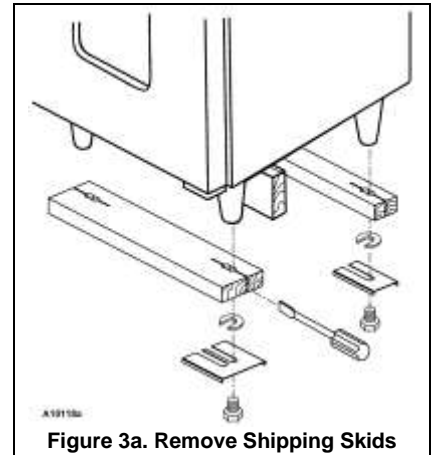

Figure 3a. Remove Shipping Skids

INSTALLATION

- Consult local, state and federal codes and regulations before installing the vendor.
- Retrieve the keys to the vendor from the coin return cup.
- Open outer door and remove all internal packing material.

REMOVING THE DOOR

The door can be temporarily removed to move the vending machine through a narrow opening.

CAUTION: Disconnect the power cord from the wall outlet before servicing. Follow all safety precautions and use appropriate moving equipment. The vending machine is HEAVY. At least two persons must be involved in moving the cabinet and/or removing the door.

1. **Mark the top and bottom hinge locations** - The marks will be used as a reference later on during reassembly.
2. **Disconnect door harnesses** - Loosen the nut and bolt attaching the harness retaining spring to the door harness and unhook the spring from the harness. Unplug the door harness. Unplug the door glass heater harness from the power panel. (Figure 4a).
3. **Remove the door** - While holding the door in place to prevent bending or damage to the bottom pivot, remove the two (2) small locating screws and four (4) large bolts and nuts holding the Top Hinge Plate to the cabinet. (Figure 4b). Save the mounting hardware for step 7. Lift the door to remove it from the bottom hinge.
4. **Retract the Front Legs** - Start with the Left Front Leg. From underneath the machine, loosen the two screws shown in Figure 4d. Remove the remaining 4 screws and the large screw. (Figure 4c). Remove the Left Hinge Reinforcement and the Door Lifter. Save all parts for step 5. Push the Left Front Leg in so that it is flush with the cabinet. Tighten the two (2) screws underneath.



Figure 4a. Door Harness



Figure 4b. Top Hinge Plate

Move to the Right Front Leg. From underneath the machine, loosen the two (2) screws shown in Figure 4f. Remove the remaining four (4) screws and also the large screw. (Figure 4e). Remove the Bottom Hinge Reinforcement. Save all parts for step 6. Push the Right Front Leg in so that it is flush with the cabinet. Tighten the two (2) screws underneath.

5. **Move the vending machine and door to the desired location.**
6. **Extend the Front Legs** - Start with the Left Front Leg. Loosen the two (2) bottom screws. Pull the leg forward to its original position. Install the Hinge Reinforcement under the leg. Tighten the two screws and install the four (4) large screws (saved from step 4) through the bottom.



Figure 4c. Left Front Leg

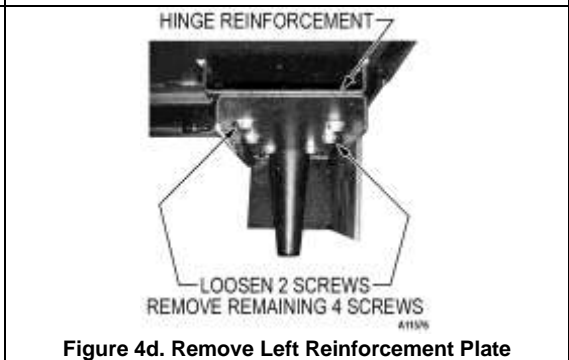

Figure 4d. Remove Left Reinforcement Plate

Reinstall the Door Lift on top. Use the fasteners saved from step 4. Install the four (4) large screws through the bottom. Reinstall the Door Hinge, nuts and large screw on top (Figure 4e). Tighten all fasteners.

Go to the Right Leg. Loosen the two (2) bottom screws. Pull the leg forward. Install the Hinge Reinforcement underneath. Use the fasteners saved from step 4. Install the four (4) large screws through the bottom. Reinstall the Door Hinge, nuts and large screw on top (Figure 4e). Tighten all fasteners.

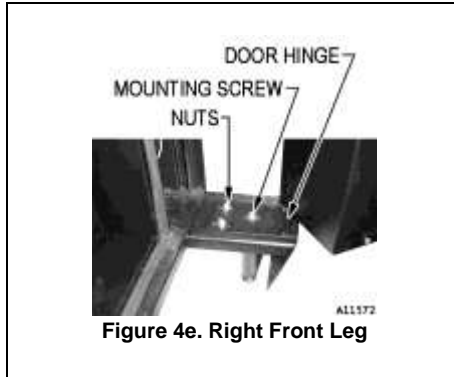

Figure 4e. Right Front Leg

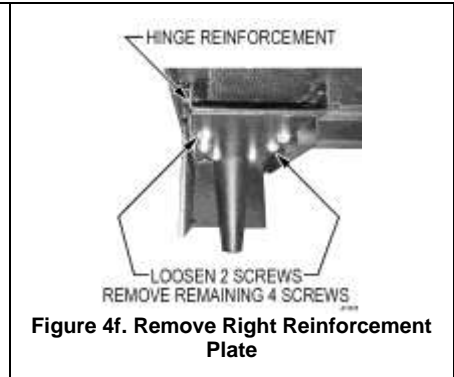

Figure 4f. Remove Right Reinforcement Plate

7. **Reattach the door** - Attach the bottom end of the door to the Door Hinge. Hold the door in place while attaching the Top Hinge Plate to the cabinet using the hardware fasteners saved from step 3 (Figure 4b). First, install the two (2) small screws to locate the Top Hinge Plate to the correct location and then add the four bolts and nuts.
8. **Connect door harnesses** - Plug the door glass heater harness to the power panel. Plug the door harness to the cabinet harness. Hook the harness retaining spring to the bolt and tighten the nut. See Figure 4a.

POWER CORD

The power cord is coiled inside the connection cover near the left lower corner as viewed from the back of the vending machine. Remove the retaining screw and uncoil the power cord. Route it under the cover as shown in Figure 4g. Keep power cord secured on the center back of the cabinet until the vendor is placed into its final location to prevent damage to the cord.

Position the vendor in its place of operation no farther than nine feet from the power outlet or receptacle. Check that the door will open fully without interference. Leave at least four (4") inches of space between the back of the vending machine and any wall or obstruction for proper air circulation.

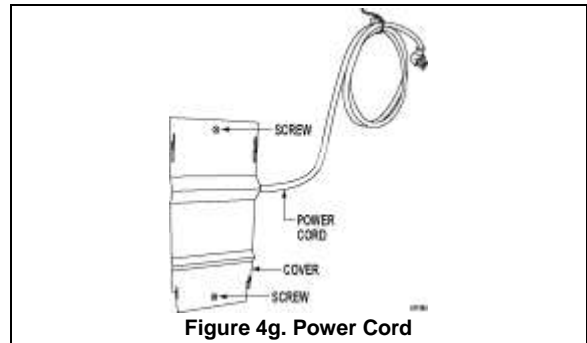

Figure 4g. Power Cord

LEVEL THE VENDOR

All levelers must touch the floor. The vendor **must** be level for proper operation, cabinet to door alignment and for acceptance of coins through the coin mechanism.

GROUNDING (EARTHING) & ELECTRICAL

Before connecting the vendor, the integrity of the main electrical supply must be checked for correct polarity, presence of ground (earth) and correct voltage. Please refer to the **Safety Manual and Installation Guidelines Manual** (P/N 4206816) that shipped in the service package with your vending machine. These checks should be repeated at six (6) month intervals with the routine safety electrical testing of the vendor itself.

If the receptacle is not properly grounded or polarized, you should contact a licensed electrician to correctly polarize and/or ground the receptacle to ensure safe operation.

A noise suppressor has been installed in this vending machine to compensate for any mains signal noise that could interfere with the normal operation of the controller.

For proper operation of any equipment utilizing electronically controlled components, the equipment should be placed on an isolated or dedicated noise-free circuit, properly polarized and grounded.

MAIN POWER SWITCH

Plug the power cord to a dedicated power outlet. Open the vendor door. Turn on the main power switch located on the lower right hand side of the vendor. See Figure 4h.

DOOR GLASS HEATER SWITCH

This switch is normally turned off to conserve energy. Turn the switch on only if the vendor is in a humid location and water condensates on the glass. See Figure 4h.

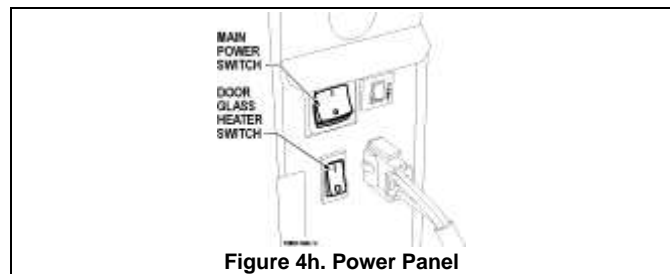

Figure 4h. Power Panel

ADVANCED POWER MANAGEMENT

See **GVC2 Programming Manual** (P/N 4215507) for more information.

LOADING PRODUCTS

All trays of a single zone and all trays in the bottom compartment of dual zone machines are for can, bottle or food products requiring cool temperatures. The trays in the top compartment of dual zone machines are designed for snacks, chips and chocolate products not requiring cooler temperatures.

Load product from front to back making sure all items fit freely between the auger spaces. Do not attempt to force oversized items or packages into the spaces. Do not skip a space. Place the product on the bottom of the compartment on the product augers with the label facing the front of the vending machine for easy identification by the customer. See Figure 5a.

SNACK/CANDY/FOOD TRAY OPTION

To load products, lift the tray slightly and pull forward until the tray stops. The trays tilt for easier loading.

The size of the item being vended must be larger than the diameter of the auger being used to vend properly.

Undersize items could cause vend problems. If the product does not fit the auger properly, use a different pitched auger. See TABLE 1 for augers available from your distributor or service entity.

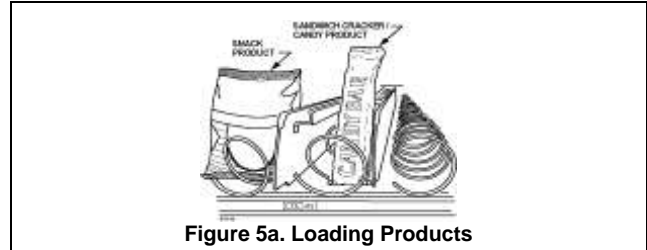
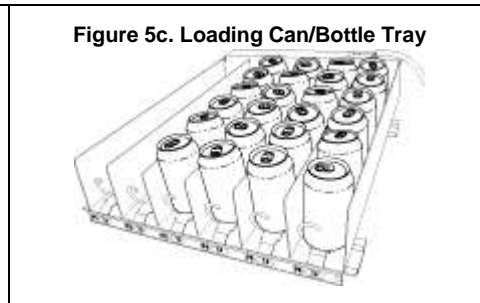
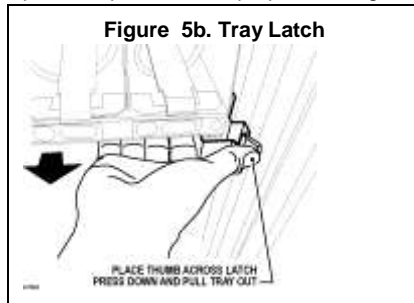

Figure 5a. Loading Products

CAN/BOTTLE TRAY OPTION

TRAY LATCH

Place thumb across latch, press down to the right and pull the tray out. See Figure 5b. Place product vertically as shown in Figure 5c. Some bottle beverages may require an optional kit for proper vending.



DISPENSER MECHANISM OPTION

Load product horizontally from front to rear and stack a maximum of three (3) levels high. See Figure 5d.

Install product labels (flavor tabs) in the space provided above the price and selection labels.

Figure 5d. Loading Dispenser Mechanism



TABLE 1. AVAILABLE AUGERS

| TYPE | PRODUCT | | | PART NUMBER |
|-----------------------|--------------|--------------|-----|----------------|
| | WIDTH (INCH) | THICK (INCH) | QTY | |
| CANDY | 2.75 | 0.50 | 30 | 4200272.103309 |
| | | 0.66 | 24 | 4200272.102309 |
| | | 0.94 | 18 | 4200272.101309 |
| | | 1.19 | 15 | 4200272.100309 |
| | | 1.50 | 12 | 4200272.104309 |
| | | 2.03 | 9 | 4200272.105309 |
| | | 3.09 | 6 | 4200272.106309 |
| CAN/BOTTLE | 2.75 | 3.09 | 6 | 4200272.106309 |
| DISPENSER (12 OZ CAN) | 4.84 | 2.59 DIA | 8 | 4214090 |
| SNACK | 5.50 | 1.19 | 15 | 4200272.109309 |
| | | 1.50 | 12 | 4200272.108309 |
| | | 1.81 | 10 | 4200272.107309 |
| | | 2.62 | 8 | 4200272.111309 |
| | | 2.69 | 7 | 4200272.110309 |

TRAY ADJUSTMENTS

By re-timing the augers, difficult-to-vend items can be dispensed more dependably. By altering tray spacing, larger items can be vended. By changing the tray configuration, different product mixes can be accommodated.

VERTICAL SPACING

The trays can be adjusted up or down in half-inch increments to provide additional headroom for vending taller products. When increasing the height in one area, the same amount of room will be lost at the tray above or below the one being adjusted.

3 WIDE SNACK/CANDY/FOOD TRAY

1. Pull out the tray to be adjusted until it stops.
2. Disengage the tray harness from its retainer on the right side wall. See Figure 6a on page 7. Disconnect the tray plug from its receptacle on the right side wall.
3. Lift up on the rear of the tray and remove it from the vendor.
4. Disengage left and right tray rails from their corresponding slots on the left and right side walls by pulling inward on the bottom front of each rail and lifting its flange out of the slot. Pull each rail forward to disengage its rear tabs from the hole in the rear wall.
5. Relocate both left and right rails by reversing step 4. **Rails must be level from front to back and evenly spaced from top to bottom of each side.**
6. Replace the tray by placing its rear rollers on the left and right rails and lifting up on the front of the tray as it is pressed back.
7. Install the tray plug into its receptacle on right side wall.
8. Re-engage the tray harness into its harness retainer. See Figure 6a.
9. Test vend the tray in its new position to assure that the tray plug is properly seated.

5 WIDE SNACK/CANDY/FOOD TRAY

1. Pull the tray out until it stops.
2. Locate the harness retainer on the right sidewall. (Figure 6a). Pull the tray harness out of its retainer.
3. Unplug the tray plug from its receptacle on the right side wall.
4. Lift up on the front of the tray and pull slightly (approximately 1.5 cm / .5 in) forward to clear the tray stop.
5. Locate the release lever on the left and right tray rails. (Figure 6b). Swing the release levers up to unlatch.
6. Lift up on the rear of the tray and remove from the vendor.
7. Relocate both left and right tray rails from the left and right sidewalls.
8. Remove tray rail mounting screws.
9. Pull each rail forward to disengage its rear tab from the hole in the rear wall. (Figure 6b).
10. Relocate left and right rails by reversing step 7. **Rails must be level front to back and left to right.**
11. Replace the tray by placing its rear rollers on the left and right rails and lifting up on the front of the tray as you push it back
12. Swing the tray rail release levers all the way down
13. Install the tray plug into its receptacle on the right side wall.
14. Re-engage the tray harness into its harness retainer.
15. Test vend the tray in its new position to assure that the tray plug is properly seated.

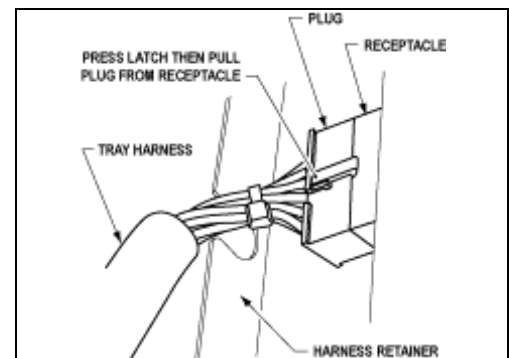

Figure 6a. Tray Harness

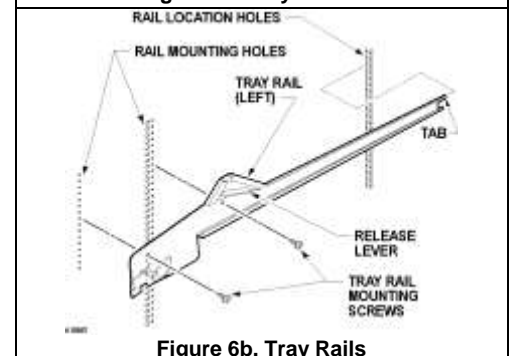

Figure 6b. Tray Rails

CAN/BOTTLE TRAY OR DISPENSER TRAY (DRAWER SLIDES)

1. Unlatch the tray and pull it all the way out until it stops.
2. Disengage the tray harness from its harness retainer on the right side wall. See Figure 6a on page 7. Disconnect the tray plug from its receptacle on the right side wall.
3. Remove and save the four (4) nuts located near the corners of underneath the tray. See Figure 6c and Figure 6d. Lift up and forward to remove the tray.

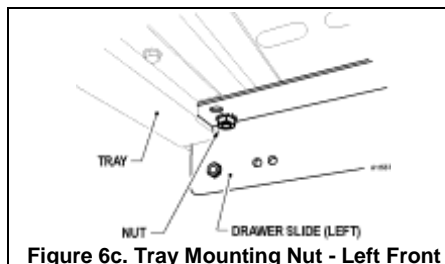

Figure 6c. Tray Mounting Nut - Left Front

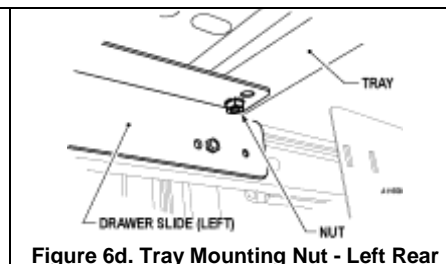

Figure 6d. Tray Mounting Nut - Left Rear

4. Remove and save the drawer slide mounting screws of both the left and right drawer slides. (Figure 6e).

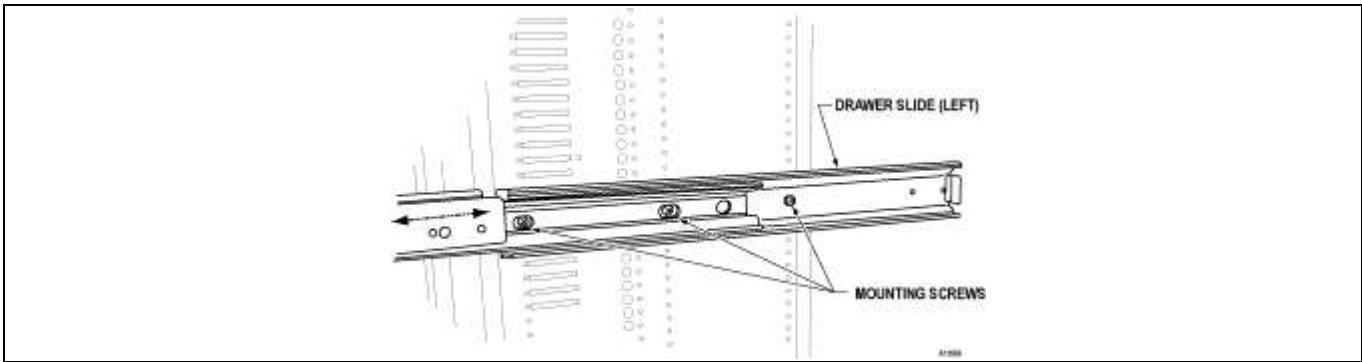

Figure 6e. Drawer Slide (Left Shown)

5. Relocate the drawer slides to their new position and attach them with the mounting screws (saved from step 4). **The drawer slides must be level front to back and left to right.**
6. Extend the slides all the way to the front and reinstall the tray. Install the four (4) nuts underneath the drawer slides.
7. Reattach the tray harness to its harness retainer on the right side wall. Connect the tray plug to its receptacle on the right side wall. See Figure 6a.
8. Push the tray into the cabinet and engage the tray latch.

CANDY TO SNACK

To change the tray configuration, order a conversion kit. See the Parts Ordering Procedure section of this manual.

SNACK TO CANDY

To change the tray configuration, order a conversion kit. See Parts Ordering Procedure section of this manual.

AUGER TIMING

SNACK/CANDY/FOOD TRAY

Each auger can be rotated in 20° (degree) increments for a different product vend drop-off point. Most items can be vended successfully when the auger end is positioned at 6 o'clock. The general rule is – **the narrower the product, the higher the timing.**

- Thick products: 4 – 6 o'clock
- Most products: 6 o'clock
- Thin products: 6 – 8 o'clock

TO CHANGE AUGER TIMING:

1. Remove the motor cover. See Figure 6f.
2. Raise the motor slightly and pull forward on the auger until it separates from the motor.
3. Rotate the auger to the desired position and re-insert the hub (auger coupling) into the motor. The hub must be seated over the vertical rail or retaining rib on the tray.
4. Replace the motor cover, making sure it is securely tightened.
5. Test vend to make sure product vends properly.

CAN/BOTTLE TRAY OPTION

1. Remove hitch pin. See Figure 6g.
2. Pull hub and auger away from the motor.
3. Rotate the hub and auger.
4. Re-insert the hub and auger
5. Re-insert the hitch pin.
6. Test vend to make sure product vends properly.

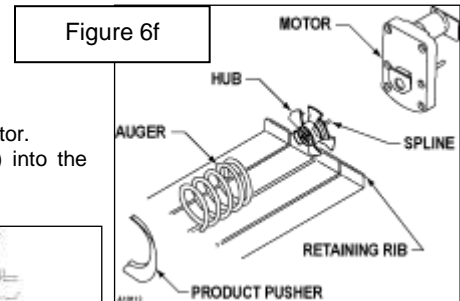

Figure 6f

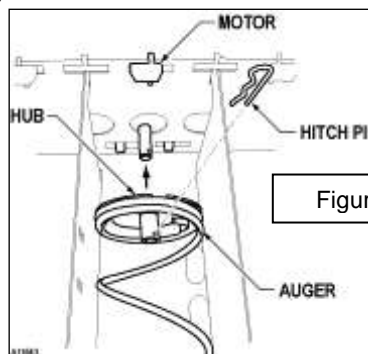

Figure 6g

CONTROLLER FUNCTIONS

IVEND™ CYCLE

All vendor selections have been assigned at the factory to be monitored for iVend™ optical sensing.

For 5 milliseconds at the start of a vend, the iVend™ optical sensor will be checked to make sure it is not blocked, damaged or disconnected.

If **blocked, damaged or disconnected** - the normal home-switch-vend cycle will be used and the optical sensors will be ignored. Both the vend motor and a vend timeout timer are started.

- The selection motor rotates to the home-switch position.
- If there is a home-switch signal, then the vend is considered successful.
- If after 10 seconds there is no home-switch signal, the vend failed. The vend motor is shut down and **MAKE ALTERNATE SELECTION** is displayed. The customer can press selection buttons to activate another motor or press the coin return button.

If not blocked, damaged or disconnected - the iVend™ Sensor System is used. The vend motor and a vend timeout timer are started.

- The selection motor rotates to the home-switch position.
- If a product is detected during this time period, then the vend is considered successful.
- If after reaching the home-switch position and a product is not detected, then the vend motor will pause for 1 second while the controller continues to monitor the optical sensor for product delivery.
 - If a product is detected during this pause, then the vend is considered successful.
 - If a product is not detected, then the controller initiates a second vend cycle and another vend timeout timer while continuing to monitor the optical sensor.
 - ✓ If a product is detected during this second cycle, the motor will be stopped immediately. The vend is considered successful. The **2ND VEND** accounting counter is increased by one.
 - ✓ If after reaching the home-switch position and a product is not detected, then the vend motor is stopped and for 2 seconds the controller continues to monitor the optical sensor for product delivery. If a product is detected, the vend is considered successful. The **2ND VEND** accounting counter is increased by one.
 - ✓ Otherwise, if no product is detected, the selection is sold out. Such a state will trigger the display of the **MAKE ALTERNATE SELECTION** message. The amount of credit is displayed. The customer can press selection buttons to activate this or another motor or press the coin return button.
 - If after 10 seconds there is no home-switch signal and no product is detected, then the vend failed. The vend motor is shut down and **MAKE ALTERNATE SELECTION** is displayed. The customer can press selection buttons to activate another motor or press the coin return button.

NOTE: Force Vend is disabled to permit customer to retrieve deposited money.

CREDIT & COUNTERS

See **GVC2 Programming Manual (P/N 4215507)** for further information.

SERVICE MODE

Use **Service Mode** to program and service the machine. Use the keypad as an input device. Watch the display for information while in Service Mode.

SERVICE MODE BUTTON

To enter **Service Mode**, press the **Service Mode Button** located on the top or upper right corner of the controller cover. (Figure 7). To exit Service Mode, press the Service Mode Button.

NOTE: If no key is pressed for approximately one minute while in Service Mode, the controller will automatically return to Sales Mode.

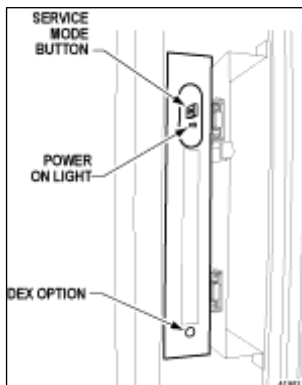

Figure 7

BASIC PROGRAMMING SETUP

KEYPAD

Use the buttons on the keypad as directed in the step-by-step instructions in this manual in programming the vendor.

DISPLAY
Check the display after pressing the **Service Mode Button** and/or **Keypad Buttons** to make sure that the program is responding correctly.

Buttons 0-9 are used to move between the various modes, menus and sub-menus; while the **#** button is used to enter a menu, confirm or save a setting.
See Figure 3

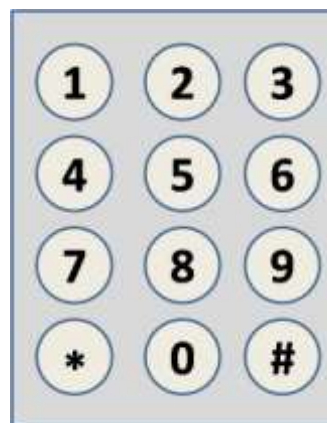



Figure 3: Keypad

1 TUBE FILL/ DISPENSE COINS





TUBE FILL

Tube Fill counts coins as they are deposited and Shows the dollar amount.

| STEP | | DISPLAY |
|------|--|----------------------------------|
| 1. | Press Service Mode Button  | Motor Count 60 |
| 2. | Press  and begin depositing coins | At least 15 of each denomination |
| 3. | Press  2 times to exit | (Sales Mode) |

TUBE DISPENSE



Tube Dispense Pays out coins from the coin mech coin tubes. This mode will also display the current quantity of coins in the coin mech tubes.

| STEP | | DISPLAY |
|------|---|--------------|
| 1. | Press  to dispense dollar coin | \$1.00/coins |
| 2. | Press  to dispense quarters | 0.25/coins |
| 3. | Press  to dispense dimes | 0.10/coins |
| 4. | Press  to dispense nickels | 0.05/coins |
| 5. | Press  2 times to exit | (Sales Mode) |

Note: For dispensing more than a 4 denomination coin mech. use keys greater in the same sequence as shown above.

2 MOTOR COUNT

Displays the total count of working motors.

| STEP | | DISPLAY |
|------|---|----------------|
| 1. | Press Service Mode Button  | Motors (- -) |
| 2. | Press  then wait. | Motors (- -) |
| 3. | Press  to exit. | (Sales Mode) |

3 OPTIONS

3.1 FORCE VEND

See GVC2 Programming Manual (P/N 4215507) for more information.

3.2 BILL ESCROW

See GVC2 Programming Manual (P/N 4215507) for more information.

3.3 MULTI VEND

See GVC2 Programming Manual (P/N 4215507) for more information.

3.4 FREE VEND

See GVC2 Programming Manual (P/N 4215507) for more information.

3.5 FAST CHANGE

See GVC2 Programming Manual (P/N 4215507) for more information.

3.6 OPTICAL VEND

See GVC2 Programming Manual (P/N 4215507) for more information.

3.7 POINT OF SALE MESSAGE (POS)

See GVC2 Programming Manual (P/N 4215507) for more information.

3.8 SETPOINT







The following are the factory default SET POINT temperature settings for each machine type:

| MACHINE TYPE | TEMPERATURE SETTINGS |
|----------------------|--|
| | <ul style="list-style-type: none"> Frozen -10F Slackened 15F Cold 36F Chilled 62F Snack N/A |
| Dual Zone | <ul style="list-style-type: none"> Bottom Zone 36F Top Zone 62F (not changeable) Delta 6F (not changeable) |
| Multi-Zone Food | <ul style="list-style-type: none"> Bottom Zone -10F Top Zone 36F |
| Multi-Zone Food-2 | <ul style="list-style-type: none"> Bottom Zone -12F Top Zone 36F |
| Multi-Zone Food-5 | <ul style="list-style-type: none"> Bottom Zone-15F Top Zone 36F |
| Single-Zone Frozen | <ul style="list-style-type: none"> -10F |
| Single-Zone Frozen-2 | <ul style="list-style-type: none"> -12F |
| Single-Zone Frozen-5 | <ul style="list-style-type: none"> -15F |
| Single-Zone Cold | <ul style="list-style-type: none"> 36F |
| Single-Zone Cold-1 | <ul style="list-style-type: none"> 35F |

These temperatures may be adjusted, however it is **not** recommended
See GVC2 Programming Manual (P/N 4215507) for more information.

3.9 KEYPAD BACKLIGHT

This menu controls the brightness level of the keypad backlight. (Default is 3)

| | STEP | DISPLAY |
|----|--|----------------|
| 1. | Press Service Mode Button  | Motors (- -) |
| 2. | Press  | Options |
| 3. | Press  to view setting. | KB Backlight |
| 4. | Press  repeatedly to change setting. Note:0=Off, 1=Low, 2=Med, 3 =High, 4=Max | KB Backlight 3 |
| 5. | Press  to save | KB Backlight 3 |
| 6. | Press  3 times to exit. | (Sales Mode) |

4 CONFIGURATION

4.1, 4.2, 4.3: CONFIGURE MACHINE TO SNACK, CAN, OR BOTTLE

See GVC2 Programming Manual (P/N 4215507) for more information.

4.4 LANGUAGE

See GVC2 Programming Manual (P/N 4215507) for more information.

4.5 AUTO REINSTATE

See GVC2 Programming Manual (P/N 4215507) for more information.

4.6 SPACE TO SALES (STS)

See GVC2 Programming Manual (P/N 4215507) for more information.

4.7 CUSTOM STS

See GVC2 Programming Manual (P/N 4215507) for more information.







4.8 TIME/DATE

Sets the time and date for timed operations.

The following submenus are available:

Date; Time; Daylight Savings

4.8.1 DATE

| STEP | | DISPLAY |
|------|---|-----------------|
| 1. | Press Service Mode Button  | Motors (- -) |
| 2. | Press  | Configuration |
| 3. | Press  | Time/ Date menu |
| 4. | Press  | MM/DD/YYYY |
| 5. | Press  to edit date | 06/01/2007 |
| 6. | Press  to save. | 06/01/2007 |
| 7. | Press  4 times to exit | Sales Mode |

4.8.2 TIME







Time Setting - This menu controls and displays the current time of day. The display will show a 24 hour format.

Examples:

8:05 a.m. = TIME 08.05

01:15 p.m. = TIME 13.15

11:45 p.m. = TIME 23.45

| STEP | | DISPLAY |
|------|---|----------------|
| 1. | Press Service Mode Button  | Motors (- -) |
| 2. | Press  | Configuration |
| 3. | Press  | Date/ Time |
| 4. | Press  for Time menu | 08:00:25 |
| 5. | Press  to edit | 09:00:25 |
| 6. | Press  to save | 09:00:25 |
| 7. | Press  4 times to exit | Sales Mode |









Daylight Savings Settings:

See GVC2 Programming Manual (P/N 4215507) for more information.

4.9 HEALTH SAFETY (HS)

Health Safety - This menu allows the user to specify the operating region to meet health safety requirements. The health safety requirements can be applied to an individual Item(s), Row(s), or ALL (whole machine). If the requirements are violated then the Item(s), Row(s) or the whole machine will be shut down accordingly.

4.9.3 HS "All"

| STEP | | DISPLAY |
|------|---|------------------|
| 1. | Press Service Mode Button  | Motors (- -) |
| 2. | Press  | Configuration |
| 3. | Press  | Health Safety |
| 4. | Press  to toggle All ON/OFF | All Items ON/OFF |
| 5. | Press  to save | All Items ON |
| 6. | Press  to exit | Health Safety |
| 7. | Press  to toggle HS ON/OFF (default is ON) | Enable ON |
| 8. | Press  to save | Enable OFF |
| 9. | Press  4 times to exit | Sales Mode |

4.0 ADVANCED CONFIGURATION

NOTE: *THIS IS PASSWORD PROTECTED (2314 DEFAULT)*

4.0.1 BEEP ENABLE

See GVC 2 Programming Manual (P/N 4215507) for more information

4.0.2 OPTICS DISABLES

See GVC 2 Programming Manual (P/N 4215507) for more information

4.0.3 MOTOR TYPE

See GVC 2 Programming Manual (P/N 4215507) for more information

4.0.4 TALKER

See GVC 2 Programming Manual (P/N 4215507) for more information.

4.0.5 PASSWORD







See GVC2 Programming Manual (P/N 4215507) for more information.

4.0.6 SET DEFAULTS

See GVC2 Programming Manual (P/N 4215507) for more information.

4.0.7 MACHINE TYPE REFRIGERATION SETTING

This menu allows the board to electronically control the refrigeration system.

| STEP | | DISPLAY |
|------|--|---|
| 1. | Press Service Mode Button  | Motors (- -) |
| 2. | Press  | Configuration |
| 3. | Press  | Password |
| 4. | Enter Password (default 2314) | **** |
| 5. | Press  to edit Refrigeration Type. Default is Snack | Cold Slackened Frozen Dual Zone Chilled Snack MZF MZF-2 MZF-5 SZF SZF-2 SZF-5 SZC SZC-1 |
| 6. | Press  to save | Temp Slackened |
| 7. | Press  4 times to exit | Sales Mode |

4.0.8 SEL STYLE

How USD satellite selections will be chosen on the keypad.

See GVC 2 Programming Manual (P/N 4215507) for more information.

5 PRICING

Price Setting - This menu allows these methods for assigning prices:

- ITEM — by individual selections
- ROW— by shelf or tray
- ALL ITEMS — by entire machine.
- COUPONS — by Item, Row, or ALL
- TOKENS — by Item, Row, or ALL
- COMBO

The maximum price that can be set is \$655.35.

5.1 ALL





This menu allows you to set the selection price of every item all at once.

Time Saving Suggestion: *Instead of setting the price of each item one at a time, it is much faster to set the common price of the entire machine; then go back and set the price of each item or row.*





5.2 ROW

Use this menu to set the price of a row (shelf) all at the same time.

Time Saving Suggestion: *Instead of setting the price of one item at a time, set the common price of a Row, then go back and set the price of each item.*

| STEP | | DISPLAY |
|------|--|-----------------|
| 1. | Press Service Mode Button  | Motors (- -) |
| 2. | Press  | Pricing |
| 3. | Press  | Row: - - \$0.00 |
| 4. | Enter row number and price <i>Example: Top row=01, row below top row=02, etc.</i> Program will automatically go to the next Row. | Row:01 \$0.50 |
| 5. | Press  to save. | Row 01 \$0.50 |
| 6. | Press  3 times to exit | (Sales Mode) |

5.3 ITEM

| STEP | | DISPLAY |
|------|--|-----------------|
| 1. | Press Service Mode Button  | Motors (- -) |
| 2. | Press  | Pricing |
| 3. | Press  | Item |
| 4. | Enter Item and price | Item 010 \$0.50 |
| 5. | Press  to save. The program will automatically go to the next selection number. | Item 010 \$0.50 |
| 6. | Press  3 times to exit. | (Sales Mode) |

5.4 COUPON OR TOKEN

Allows the operator to designate the values of coupons or tokens that are accepted by pre-programmed validators
See GVC2 Programming Manual (P/N 4215507) for more information.

6 ACCOUNTING





Use this menu to gain access to menus that display or reset data for various types of cash and vend totals. Counts can be viewed by individual items, rows or as the whole machine.

See GVC2 Programming Manual (P/N 4215507) for more information.

7 ADVANCED OPTIONS



To enter this menu you will be prompted to input a password. The following options are available: Discount, Promo Vend, Free Vend Rate, Exact Change, Unconditional Acceptance, Max Change, Programmable POS, Shutdown, Energy Savings.

7.1 – 7.9: See GVC2 Programming Manual (P/N 4215507) for more information.

| STEP | | DISPLAY |
|------|---|------------------|
| 1. | Press Service Mode Button  | Motors (- -) |
| 2. | Press  | Pricing |
| 3. | Press  to enter price | ALL Items \$0.50 |
| 4. | Press  to save. | ALL Items \$0.50 |
| 5. | Press  3 times to exit. | (Sales Mode) |

8 TEST VEND



Use this menu to test vend individual motors. The selection will display with the test vend. If a test vend attempt on a particular motor fails, controller will beep.

| STEP | | DISPLAY |
|------|---|----------------|
| 1. | Press Service Mode Button  | Motors (- -) |
| 2. | Press  | Item - - - |
| 3. | Press selection number on keypad and wait | Item 010 |
| 4. | Repeat step 3 for other selections. | |
| 5. | Press  3 times to exit. | (Sales Mode) |

8.1 TEST ALL MOTORS





This menu will test vend all motors. The selection will display with the test vend. If a test vend attempt on a particular motor fails, then the controller will beep. Satellite machines will also be included in the test.

NOTE: Pressing  at any time will stop the test

| STEP | | DISPLAY |
|------|---|----------------|
| 1. | Press Service Mode Button  | Motors (- -) |
| 2. | Press  and wait. | Item |
| 3. | The motor selection number will display while it is being tested. | Item 010 |
| 4. | Press  3 times to exit. | (Sales Mode) |

0 DIAGNOSTIC

This menu is used to perform a self-diagnostics check and display results

| STEP | | DISPLAY |
|------|--|--|
| 1. | Press Service Mode Button  | Motors (- -) |
| 2. | Press  | Diagnostic... |
| | Press  to start test | Checksum Temp Sensor Optical Coin Acceptor Bill Validator Card Reader1 Card Reader2 Tests Completed |
| 3. | Press  3 times to exit. | (Sales Mode) |

0.2 TEST RELAY

See GVC2 Programming Manual (P/N 4215507) for more information.

0.3 LOG

See GVC2 Programming Manual (P/N 4215507) for more information.

0.4 COIN REJECT RATE

See GVC2 Programming Manual (P/N 4215507) for more information.

0.5 BILL REJECT RATE

See GVC2 Programming Manual (P/N 4215507) for more information.







0.6 IVEND ALIGNED

See GVC2 Programming Manual (P/N 4215507) for more information.





0.7 PASSWORD

See GVC2 Programming Manual (P/N 4215507) for more information.





0.7.1 REFRIG LOG

| STEP | | DISPLAY |
|------|---|--|
| 1. | Press Service Mode Button  | Motors (- -) |
| 2. | Press  | Diagnostics |
| 3. | Press  | Password: |
| 4. | Enter Password (default-2314) | Log |
| 5. | Press  | Refrig Log (Current Status) *- exit 1- edit |
| 6. | Press  to toggle ON/OFF | Refrig Log (Choice Flashing) *- exit # - save |
| 7. | Press  to save | Refrig Log (New Status) *- exit 1- edit |
| 8. | Press  4 times to exit. | (Sales Mode) |







0.7.2 DAQ LOG

| STEP | | DISPLAY |
|------|---|--|
| 1. | Press Service Mode Button  | Motors (- -) |
| 2. | Press  | Diagnostics |
| 3. | Press  | Password: |
| 4. | Enter Password (default-2314) | Log |
| 5. | Press  | DAQ Log (after a few seconds, display changes to Log) |
| 8. | Press  3 times to exit. | (Sales Mode) |







0.7.3 STS

| STEP | | DISPLAY |
|------|--|--|
| 1. | Press Service Mode Button  | Motors (- -) |
| 2. | Press  | Diagnostics |
| 3. | Press  | Password: |
| 4. | Enter Password (default-2314) | Log |
| 5. | Press  | StS (after a few seconds, display changes to Log) |
| 8. | Press  3 times to exit. | (Sales Mode) |

0.7.4 HEALTH SAFETY TEST

| STEP | | DISPLAY |
|------|---|---|
| 1. | Press Service Mode Button  | Motors (- -) |
| 2. | Press  | Diagnostics |
| 3. | Press  | Password: |
| 4. | Enter Password (default-2314) | Log |
| 5. | Press  | HS Test (Current Status) *- exit 1- edit |
| 6. | Press  to toggle ON/OFF | HS Test (Choice Flashing) *- exit # - save |
| 7. | Press  to save | HS Test (New Status) *- exit 1- edit |
| 8. | Press  4 times to exit. | (Sales Mode) |

0.9 MANUAL DEFROST

| | STEP | DISPLAY |
|----|---|--|
| 1. | Press Service Mode Button  | Motors (- -) |
| 2. | Press  | Diagnostics |
| 3. | Press  | Manual Defrost (Current Status) *- exit 9- edit |
| 4. | Press  to toggle ON/OFF | Manual Defrost (Choice Flashing) *- exit # - save |
| 5. | Press  to save | HS Test (New Status) *- exit 1- edit |
| 6. | Press  3 times to exit. | (Sales Mode) |

CUSTOMER LEAD THROUGH MESSAGES

The following messages will be affected by the language selection and are stored in the controller memory.

Message 1: PLEASE USE EXACT CHANGE

Message 2: PLEASE INSERT MORE MONEY

Message 3: PLEASE MAKE ANOTHER SELECTION

Message 4: OUT OF SERVICE

Message 5: VENDING OPERATION TO RESUME AT (hh.mm)

Message 6: DOOR OPEN ERROR

Message 7: THANK YOU

Message 8: FREE ON US

For Other Languages, See GVC2 Programming Manual (P/N 4215507).

TEMPERATURE CONTROL

To prevent damage to the refrigeration unit when it is turned off or the power is interrupted, the refrigeration unit will not restart for at least three minutes regardless of the temperature.

SENSORS

Temperature sensor(s) are positioned to best represent the product temperature. The sensor(s) are monitored by the controller program. The refrigeration and optional heater systems are activated depending on the target temperature setting or **SET POINT**. The total allowable temperature variation from the **SET POINT** is **DELTA**.

SENSOR1

Single Zone versions have **SENSOR1** located near the top of the back panel. Dual Zone versions have **SENSOR1** located near the bottom of the back panel.

SENSOR2

Dual Zone versions may have an optional **SENSOR2** mounted near the top of the back panel.

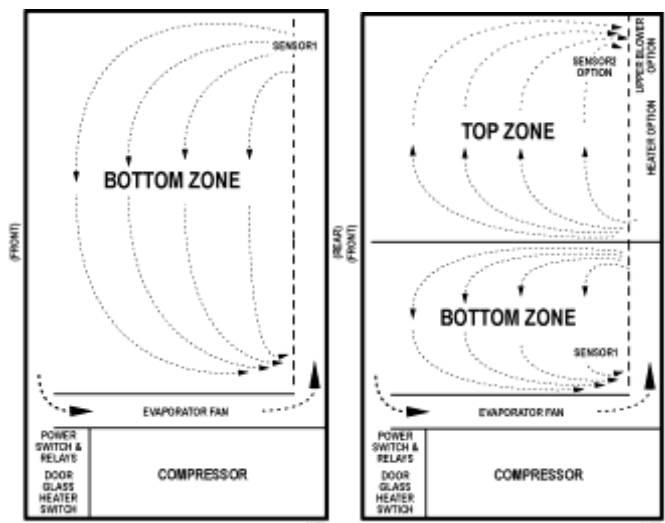

RELAYS

The program controls three relays which then control the refrigeration and heating systems:

- **RELAY1** - controls the compressor and the condenser fan (refrigeration system).

- **RELAY2** - controls the evaporator fan (refrigeration system).
 - **RELAY3 OPTION** - controls the optional upper zone blower and heater system.
- NOTE:** For more information regarding the Power Panel, please refer to Accessing the Power Panel on page 27.

DOOR SWITCH

The door switch is located in the upper right hand corner of the vending machine cabinet. Please see Accessing the Power Panel on page 27. **If the vending machine is plugged in and the power switch is on and the door is open**, then the compressor, evaporator fan, heater and heater fan are all turned off. A 30 minute door timer starts and a compressor delay timer starts.

- **If the door is open for more than 30 minutes**, the controller will resume *closed door* operation, the message **DOOR ALERT** is displayed and error code is set.
- **If the door is closed**, then evaporator fan is turned on. When the compressor delay timer expires, then the controller evaluates the zone sensor readings, relay states and timers.

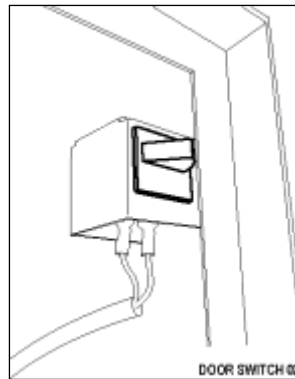

Figure 9c

FACTORY DEFAULT SETTINGS

NOTE: Please read and follow the step-by-step instructions in the GVC2 Programming Manual (P/N 4215507) to change the factory default settings.

| PROGRAM MODE | | PROGRAM VERSION | PROGRAM VERSION |
|------------------|---|---------------------------|-----------------------------|
| | | ENGLISH | SPANISH |
| TEMPERATURE MODE | DEGREE | °F (Fahrenheit) | °C (Celsius) |
| | | COLD | COLD |
| | | OFF | OFF |
| PRICE • ITEM(S) | | All selections set to .75 | All selections set to 50.00 |
| SENSOR1 | SET POINT | 36°F | 39°F (4 C) |
| | DELTA | 7°F | 7°F (4 C) |
| | DEFROST DURATION | 15 MIN | 15 MIN |
| | DEFROST PERIOD (Comp Continuous Run Time) | 2 HRS | 2 HRS |
| | DEFROST DELAY (timer) | 8 HRS | 8 HRS |
| | HEALTH SAFETY | COLD | COLD |
| | RANGE (health/safety) | All | All |
| SENSOR2 OPTION | SET POINT | 63°F | 63°F (16 C) |
| | DELTA | 5°F | 5°F (3 C) |

BOTTOM (COOL) ZONE

For a Single Zone vending machine, the entire tray compartment is the Bottom (Cool) Zone. For a Dual Zone vending machine, the product trays contained below the insulating barrier is the Bottom (Cool) Zone.

The evaporator is located between the lowest tray and the compressor. The evaporator fan distributes cold air to products in the bottom zone. The refrigeration compressor is fully insulated and is located below the bottom (cool) zone.

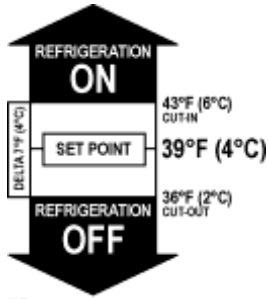

Figure 9d

CUT-IN

The refrigeration system is turned on when the temperature reading of **SENSOR1** is greater than or equal to **SET POINT** plus half of **DELTA**.

CUT-OUT

The refrigeration system is turned off when the temperature reading of **SENSOR1** is less than or equal to **SET POINT** minus half of **DELTA**.

HEALTH SAFETY

The **HEALTH SAFETY** feature prevents the sale of perishable food if the air temperature inside the bottom zone (**SENSOR1**) rises above the health safety temperature limits for cold food products (41°F / 5°C) for more than 15 minutes. The **SZF/DZF Vendor** can vend cold food products that require storage temperatures in the range of 32°F to 41°F.

NOTE: The time requirements for the **COLD** setting do not apply for 30 minutes immediately following vending machine filling or servicing.

IMPORTANT! The operator is responsible for enabling the health safety for the product being vended.

Refer to the GVC2 Programming Manual (P/N 4215507) for additional instructions on how to set the **Health Safety** and **Health Safety Range**.

TOP (WARM) ZONE

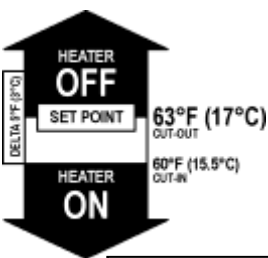

Figure 9e

If the vending machine is a Dual Zone, then the trays above the barrier are in the Top (Warm) Zone. If the optional heater system is installed, then an optional temperature **SENSOR2** is also installed.

The optional heater is inside the air duct located on the back of the cabinet. An optional blower fan is located on the top corner above the heater. The blower is turned on if the temperature is outside of the setting (**SET POINT** plus or minus half of **DELTA**).

CUT-IN

The heater turns on when **SENSOR2** temperature is less than or equal to **SET POINT** minus half of **DELTA**.

CUT-OUT

The heater turns off if **SENSOR2** reading equals the **SET POINT** or if the compressor is on.

REFRIGERATION

To prevent damage to the refrigeration unit when it is turned off or the power is interrupted, the refrigeration unit will not restart for at least three minutes regardless of the temperature.

REFRIGERATION TROUBLESHOOTING

CAUTION: Breaking the refrigerant joints or seals on the system voids the unit warranty. Failure to keep the condenser coil clean and free of dirt and dust and other similar debris voids the unit warranty.

Know and understand how the unit operates. Units may vary, but the operation is basically the same. Never guess at the problem; find the symptom before attempting any repair.

NOTE: Most refrigeration problems are electrical.

WARNING: Wiring diagrams must be followed as shown. Wrong wiring may cause serious electrical hazard and potential damage or rupture component electrical parts.

TABLE 2. APPROXIMATE WINDING RESISTANCE

| Across Terminals | Panasonic Super 1/3 Hp | Danfoss 1/2 Hp |
|------------------|------------------------|----------------|
| COMMON to START: | 7.53 Ohms | 2.9 Ohms |
| COMMON to RUN: | 1.06 Ohms | 0.7 Ohms |
| COMMON to SHELL: | No continuity | No continuity |

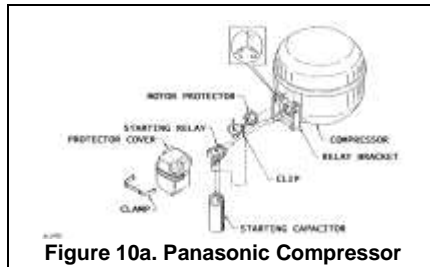

Figure 10a. Panasonic Compressor

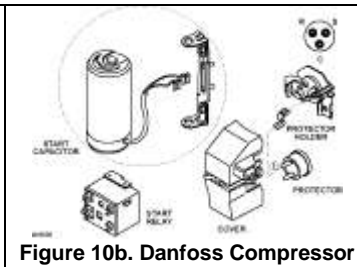

Figure 10b. Danfoss Compressor

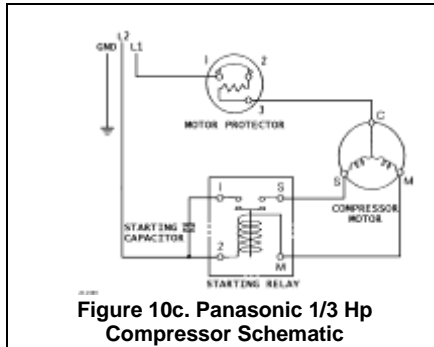

Figure 10c. Panasonic 1/3 Hp Compressor Schematic

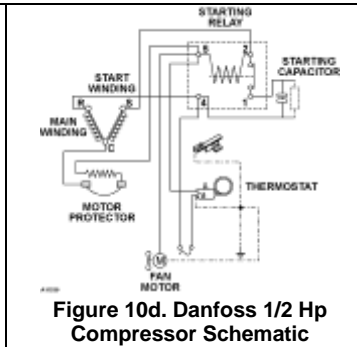

Figure 10d. Danfoss 1/2 Hp Compressor Schematic

NOTE: The sealed hermetic system should not be worked on outside the Factory Service Center.

COMPRESSOR WILL NOT START

Compressor has no power:

- Vending machine not plugged in.
- Tripped circuit breaker or blown fuse.
- Faulty wall outlet or improper wiring.
- Faulty (short or open) power cord.
- Low voltage. Check the power source with a volt meter. Minimum 103V for 115VAC, 60Hz. Minimum 195V for 230VAC, 50 Hz.
- Check motor protector (overload). See page 21,
- Troubleshooting Circuits with Multi-Meter.
- Check compressor starting relay. See
- Troubleshooting Circuits with Multi-Meter.
- Check compressor winding. See
- Troubleshooting Circuits with Multi-Meter.
- Defective refrigeration relay. Switch the controller to **Service Mode** then verify that the relay turns on by using the **TEST RELAY** menu.
- Unplug power to the vending machine. Open the power panel. Use insulated jumper wires to short the wire terminals on **RELAY1**; between 2 and 4 and between 6 and 8. Restore power to the vending machine. The compressor should start, indicating a problem in the control circuit.
- Check relay terminals 1 to 0 with a Multi-Meter. Should have 24VDC applied to them.
- Check the door switch operation.

CAUTION: Replace air filter every 3 months to maintain proper air circulation to the condenser and to prevent dirt and debris from clogging up the condenser.

NOISY OR VIBRATING UNIT

1. Components rubbing or touching each other.
 - Check fan blades and motor.
 - Loose shrouds and harness.
 - Copper tubing.
 - Loose or unsecured parts.
 - Dirty condenser fan blades.
2. Worn or aged compressor grommets.
3. Compressor.
 - Bad valves.
 - Slugging.
 - Bad windings (Refer to TABLE 2 and schematic).
 - Voltage too low.

UNIT SHORT CYCLES

- Defective condenser fan.
- Dirty or blocked condenser coils.
- Dirty or blocked air filter.
- Dirty or blocked inlet or outlet screens.
- Defective overload (motor protector).
- Temperature sensor is defective or not mounted in the correct spot.
- Temperature setting set too warm. See Temperature Control section and Factory Default Settings section of this manual.
- Defective control board.

UNIT OPERATES LONG OR CONTINUOUSLY

1. Airflow restricted.
 - Clogged or blocked inlet screen, air filter, or outlet screen.
 - Exhaust area blocked. Vending machine too close to wall.
 - Airflow blocked by product in front of evaporator or air duct openings.
 - Faulty evaporator motor or blades causing coils to ice.
 - Loose connections on evaporator motor. Motor not running.
2. Refrigeration relay shorted. Switch the controller to **Service Mode**, and then verify that relay turns off by using the **TEST RELAY** menu.
3. Gasket leak around door.
4. Excessive load: After loading, unit runs longer to pull out excessive heat from product.
5. Shortage of refrigerant or restriction.
6. Faulty controller.
7. Ambient air temperature and relative humidity exceed manufacturer's operational standards.
8. Defective temperature sensor or sensor has been moved or remounted to wrong spot.

REFRIGERATED SPACE TOO COLD

1. Refrigeration control setting too cold.
2. See
3. Troubleshooting Circuits with Multi-Meter. Check the program **DIAGNOSTICS** and look for error codes.
4. Refrigeration relay bad. Switch the controller to **Service Mode**, and then verify that relay turns on by using the **TEST RELAY** menu. Check relay terminals for continuity with an ohmmeter.
5. Faulty controller.

REFRIGERATED SPACE TOO WARM

1. Refrigeration control setting too warm.
2. Check temperature sensor. If the temperature reading of **SENSOR1** is "111°F", then check sensor harness. See
3. Troubleshooting Circuits with Multi-Meter.
4. Refrigeration relay bad. Switch the controller to **Service Mode** and verify that the **RELAY1** turns on by using the **TEST RELAY** menu.
5. Faulty control board.
6. Restricted evaporator space.
 - Evaporator motor or blades faulty, causing the coils to ice over the evaporator.
 - Condenser airflow restricted.
 - Plugged or dirty condenser.
 - Condenser motor or blades bad.
 - Blade stuck.
 - Condensing space restricted.
 - Unit placed too close to a wall.
 - Compressor - bad valves.
 - Low charge or restriction in tube if capillary tube starts frosting 8 to 20-25 cm (10 inches) past evaporator connection tube.
 - Check for oil leaks around brazed connections.

TROUBLESHOOTING CIRCUITS WITH MULTI-METER

Caution: Power must be disconnected and fan circuit open.

1. To check the power source, use the voltage section of the Multi-Meter. Acceptable range is 103-127VAC for 115V (60Hz), or 195-255VAC 230V (50Hz).
2. **Check compressor starting relay.**
 - Panasonic 1/3 HP** - Unscrew lead terminals and remove relay from compressor. (Figure 10a and Figure 10c).
 - Keep relay upright. Use ohmmeter to check for continuity between switch terminals 1 and S. Replace relay if continuity exists.
 - Use ohmmeter to check for continuity across coil terminals 2 and M. If open then replace the starting relay.
 - 1 and 2. Replace if continuity exists.
 - Use ohmmeter to check for continuity between coil terminals 5 and 2.
 - Danfoss 1/2 HP** - Remove relay from compressor. (Figure 10b and Figure 10d).
3. Use ohmmeter to check for continuity between switch terminals **Check temperature sensor harness** to control board for continuity using ohmmeter of Multi-Meter. Replace if there is no continuity.
4. **Check compressor windings** using ohmmeter. Refer to TABLE 2, Figure 10a, Figure 10b, Figure 10c and Figure 10d..
5. **Check motor protector (overload).** Use the ohmmeter section of the Multi-Meter.
 - Panasonic 1/3 HP , Danfoss 1/2 HP** - Remove overload (Danfoss) Check between terminals 1 and 3 for continuity. If no continuity (infinity), overload may be tripped. Wait 10 min. and try again. If still no continuity, overload is defective.

ACCESSING THE POWER PANEL

CAUTION: ALWAYS DISCONNECT POWER SOURCE BEFORE SERVICING.

Remove mounting screw. Remove the ground strap screw. Lift up and pull out the Power Panel. Reinstall ground strap after reinstalling the Power Panel.

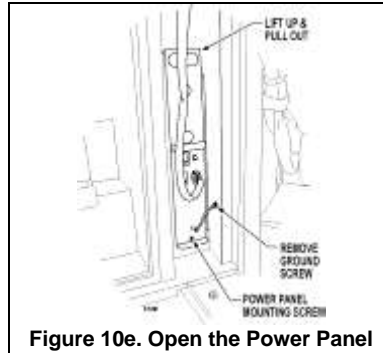

Figure 10e. Open the Power Panel

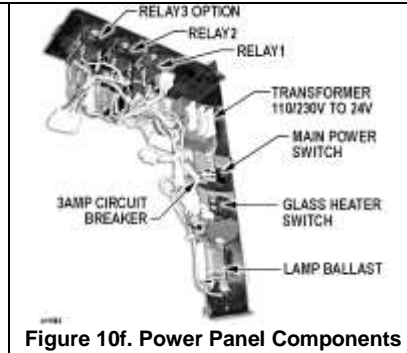

Figure 10f. Power Panel Components

REMOVING THE REFRIGERATION SYSTEM

See Advanced Service Manual

PREVENTIVE MAINTENANCE

CAUTION: Always disconnect power source BEFORE cleaning or servicing.

ONCE A MONTH

CLEAN CABINET INTERIOR

Wash with a mild detergent and water, rinse and dry thoroughly. Odors may be eliminated by including baking soda or ammonia in the cleaning solution. Plastic parts may be cleaned with a quality plastic cleaner.

The vend mechanisms must be kept clean. Any build-up can cause the mechanisms to malfunction.

DO NOT GET THE CLEANING SOLUTION ON ELECTRICAL COMPONENTS.

To insure proper vending keep delivery box area free of dirt and sticky substances.

CLEAN CABINET EXTERIOR

Wash with a mild detergent and water, rinse and dry thoroughly. Clean occasionally with a quality car wax. Plastic exterior parts may be cleaned with a quality plastic cleaner.

EVERY 3 MONTHS

REPLACE AIR FILTER

The refrigeration air filter is to prevent dust from building up on the condenser coils and allows the refrigeration system to operate efficiently.

- Pull the filter holder and check the air filter.
- If filter is dirty, replace it with the same size and type filter.
- Airflow arrow on filter must point to the left (towards the inside of vending machine).
- **On those machines with air filter handle hook filter holder around filter edge and reinstall clip on opposite end.**

WARNING: Do not replace with a HEPA type filter. This type may not allow the correct amount of air to flow through.

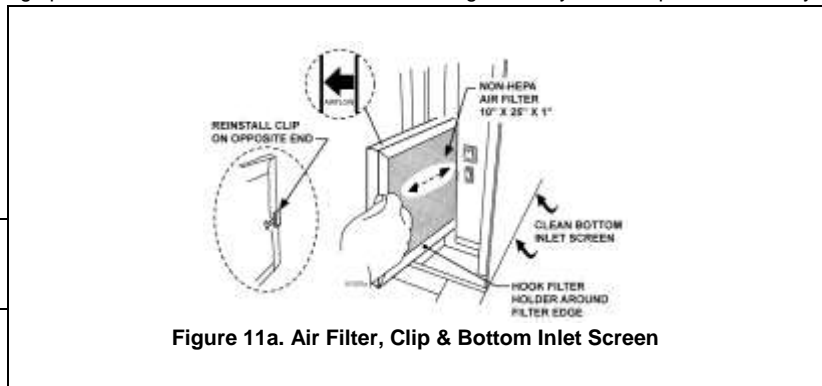

Figure 11a. Air Filter, Clip & Bottom Inlet Screen

CLEAN BOTTOM INLET SCREEN

The inlet screen is a long narrow screen located on the bottom right side. It can only be accessed from underneath the cabinet. See Figure 11a on page 22. Remove dust and debris from the inlet screen to allow air to flow to the condenser coils.

EVERY 6-MONTHS

CLEAN DOOR AND DELIVERY DOOR SEALS

Clean the door seals. Inspect them for any deformities or cracking.

CLEAN EVAPORATOR COIL

Open the door. Clean the evaporator coil of refrigeration unit using a soft bristle brush and/or vacuum cleaner.



Figure 11b. Evaporator

CLEAN REAR SCREEN

Remove the **Back Screen Cover** from cabinet back. Clean dust and debris from screen using a soft bristle brush or a vacuum cleaner.

NOTE: Remove screws from Back Screen Cover at the back of the machine, 3 from top and 2 from bottom. To remove the Back Screen Cover lift up and pull in the direction shown in **Fig. 11c**.

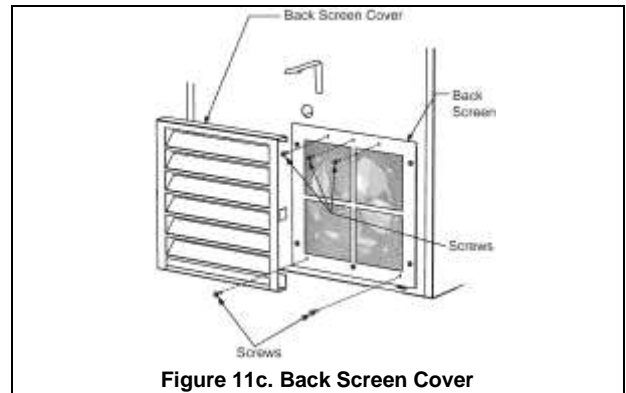

Figure 11c. Back Screen Cover

CLEAN DELIVERY BOX BOTTOM

Inspect the Delivery Box. Wipe clean any dirt and debris that may have accumulated.

The bottom half of the Delivery Box can be removed for thorough cleaning. To remove the Delivery Box Bottom, loosen the three (3) thumbnuts located on the rear of the Delivery Box. Lift up then pull it out.

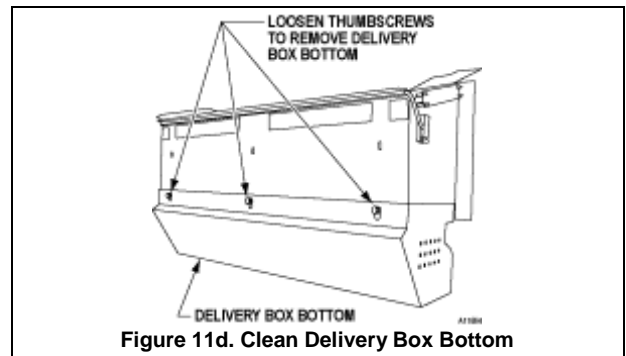

Figure 11d. Clean Delivery Box Bottom

PARTS ORDERING PROCEDURE

When ordering parts, include the following:

1. The model and serial numbers of the vending machine for which the parts are needed.
2. Shipping address.
3. Address where the invoice should be sent.
4. The number of parts required.
5. Always refer to the pertinent parts and/or part manual for the correct part number and description of a specific part.

NOTE: When RIGHT or LEFT is used with the name of a part, it means the person is facing the vending machine with the door closed.

6. Any special shipping instructions.
7. Carrier desired: air or air special, truck, parcel post or rail.
8. Signature and date.
9. Purchase order number, if used.

Mail your order to:

VendNet™
165 North 10th Street
Waukee, IA 50263 USA

All orders are carefully packed and inspected prior to shipment. Damage incurred during shipment should be reported at once and a claim filed with the terminating carrier.

If you do not have the right parts manual, contact VendNet™.

If you have any questions, check out our Website www.vendnetusa.com or call VendNet™. Ask for the Parts Department. We will be happy to assist you. Email: vendnet@vendnetusa.com

BEFORE CALLING FOR SERVICE

Please check the following:

- Does your vending machine have at least 6-inches of clear air space behind it?
- If the power is turned on at the fuse box, is the vending machine the only thing that doesn't work?
- Is the vending machine plugged directly into the outlet?

WARNING: Extension cords can cause problems.

DO NOT USE EXTENSION CORDS.

- Is the evaporator coil free of dust and dirt?
- Is the condenser coil free of dust and dirt?
- Is the compressor free of dust? A blanket of dust can prevent the compressor from cooling in between workout cycles.
- Is the circuit breaker at the fuse box reset?
- Is the evaporator fan working? To check if the fan is running take a small piece of paper in front of the evaporator coil and see if the evaporator fan will draw the paper. See Figure 11b on page 23.
- Is the condenser fan running? Fold a sheet of 8 1/2" x 11" paper in half. Place the paper in front of the condenser coil inlet screen located on the bottom right side underneath the cabinet and see if it draws the paper to it. See Figure 11a on page 22.
- Is the shelf in front of the evaporator coil clear? (No tools, product, or other air-restricting items).
- Is the temperature setting set as specified? See GVC2 Programming Manual (P/N 4215507).

NOTE: Setting the temperature colder does not accelerate cooling of product but may cause the product to freeze.

The contents of this publication are presented for informational purposes only, and while every effort has been made to ensure their accuracy, they are not to be construed as warranties or guarantees, express or implied, regarding the products or services described herein or their use or applicability. We reserve the right to modify or improve the designs or specifications of such products at any time without notice.



VendNet™
 165 North 10th Street
 Waukee, Iowa 50263
 United States of America



| | | |
|----------|---|-----------------------|
| | USA & Canada | International |
| Service | (800) 833-4411 | (515) 274-3641 |
| Parts | (888) 259-9965 | |
| Email | vendnet@vendnetusa.com | |
| Web Site | www.vendnetusa.com | |

4214792-C.DOC